



HRL 12200W

12V 200W

HRL 12200W is specially designed for high efficient discharge application. Its characteristics are high energy density, small footprint and high discharge efficiency. It can be used for more than 260 cycles at 100% discharge in cycle service, up to 10 years in standby service.



Specification

Cells per unit	6
Voltage per unit	12
Capacity	200W @15 min-rate to 1.67V per cell @25°C (77°F) 50Ah@ 20hr-rate to 1.75V per cell @25°C(77°F)
Weight	Approx. 17.6 kg(38.80 lbs)
Maximum Discharge Current	300A(5sec)
Internal Resistance	Approx. 5.9 mΩ
Operating Temperature Range	Discharge: -15°C~50°C (5°F~122°F) Charge: -15°C~40°C (5°F~104°F) Storage: -15°C~40°C (5°F~104°F)
Nominal Operating Temperature Range	25°C±3°C (77°F±5°F)
Float Charging Voltage	13.5 to 13.8 VDC/unit Average at 25°C (77°F)
Recommended Maximum Charging Current Limit	20A
Equalization and Cycle Service	14.4 to 15.0 VDC/unit Average at 25°C (77°F)
Self Discharge	CSB Batteries can be stored for more than 6 months at 25°C(77°F). Please charge batteries before using. For higher temperatures the time interval will be shorter.
Terminal	I2-Thread lead alloy recessed terminal to accept M6 bolt
Container Material	Polypropylene(UL 94-V0/File E50955)*Flammability resistance of (UL 94-HB/File E216959) can be available upon request.



MH14533(N)



ISO 9001
No :041005117



ISO 14001
NO.UM 1-12-0045

CSB-manufactured batteries are UL-recognized components under UL924 as well as ISO 9001 and ISO 14001 certified.

Dimensions

unit:(MM)

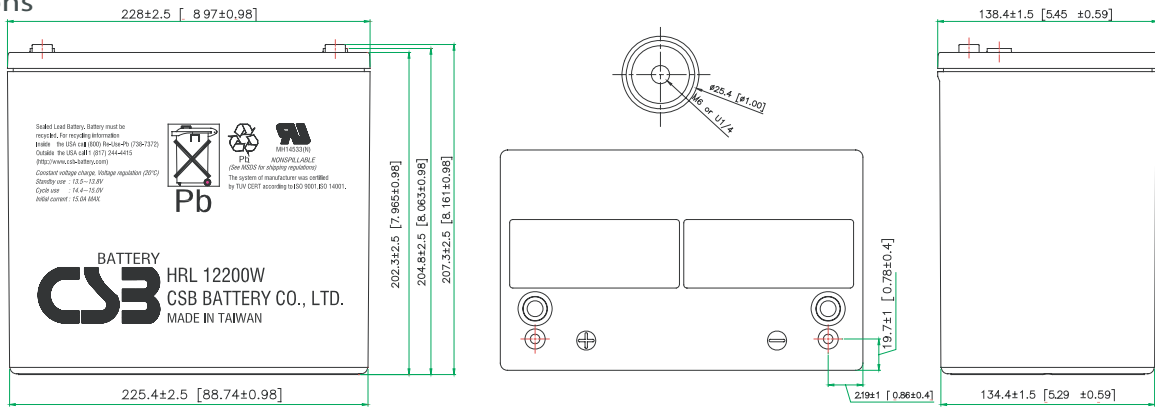

Constant Current Discharge Characteristics Unit:Ampere(25°C,77°F)

F.V/Time	5MIN	7.5MIN	10MIN	15MIN	20MIN	30MIN	40MIN	50MIN	60MIN	90MIN
1.60V	225	184	155	116	92.7	67.2	53.4	44.6	38.5	27.7
1.67V	205	169	144	110	89.4	64.7	52.0	44.3	38.1	27.4
1.70V	195	163	138	108	87.6	63.6	51.1	43.9	37.8	27.3
1.75V	177	150	128	103	83.6	61.2	49.5	42.8	37.0	26.7
1.80V	159	138	119	95.7	79.0	58.7	47.4	41.0	35.7	26.0
1.85V	142	125	110	89.3	73.4	55.6	44.8	38.1	33.3	24.8

Constant Power Discharge Characteristics Unit:Watt(25°C,77°F)

F.V/Time	5MIN	7.5MIN	10MIN	15MIN	20MIN	30MIN	40MIN	50MIN	60MIN	90MIN
1.60V	2,392	1,972	1,684	1,290	1,050	770	618	516	447	325
1.67V	2,176	1,842	1,589	1,235	1,010	748	612	514	445	323
1.70V	2,081	1,774	1,540	1,208	988	737	607	510	443	322
1.75V	1,914	1,648	1,449	1,160	945	710	594	499	434	315
1.80V	1,747	1,526	1,359	1,093	900	683	568	481	419	308
1.85V	1,584	1,410	1,258	1,031	852	649	528	450	395	295

- All mentioned values are average values.
- Tolerance: X<6min(+15%~-15%),6min ≤ X<10min(+12%~-12%),10min ≤ X<60min(+8%~-8%),X ≥ 60min(+5%~-5%)

Trickle (or Float) Service Life

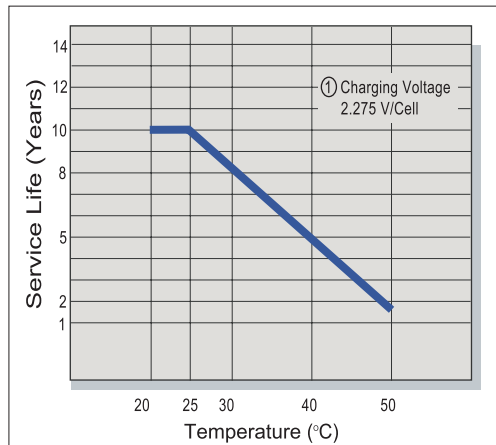

Capacity Retention Characteristic

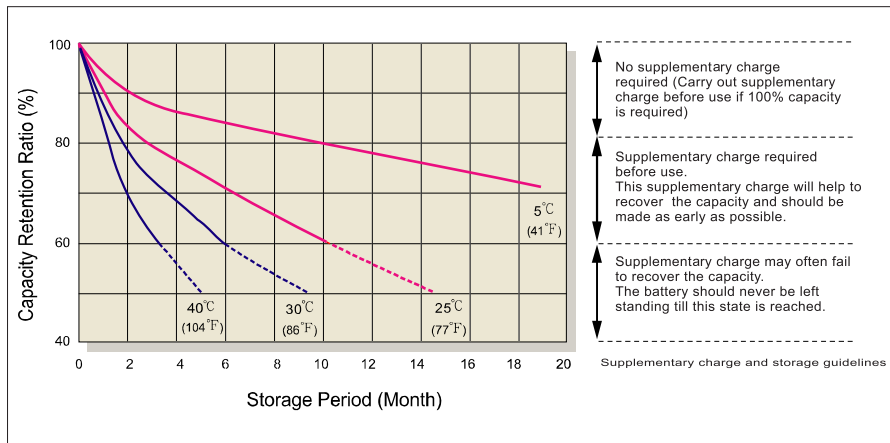

Battery Voltage and Charge Time for Standby Use

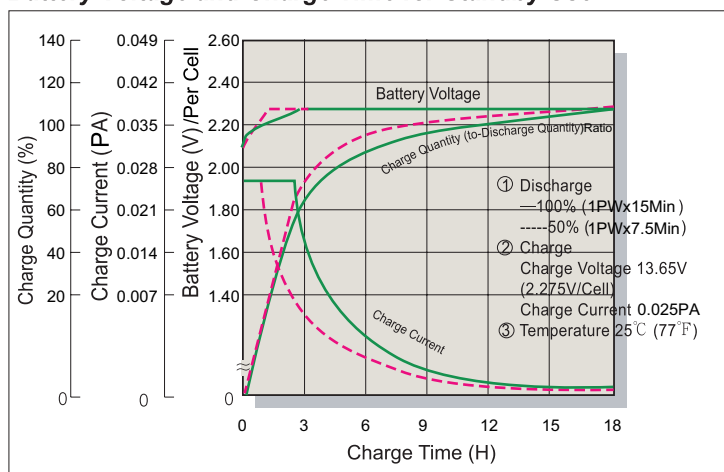

Cycle Service Life

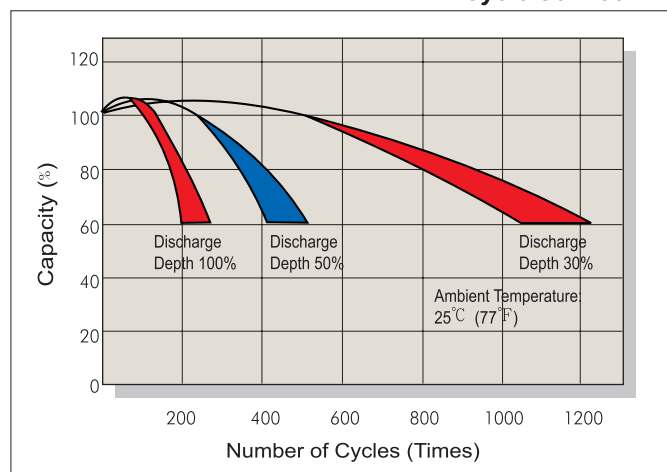

Battery Voltage and Charge Time for Cycle Use

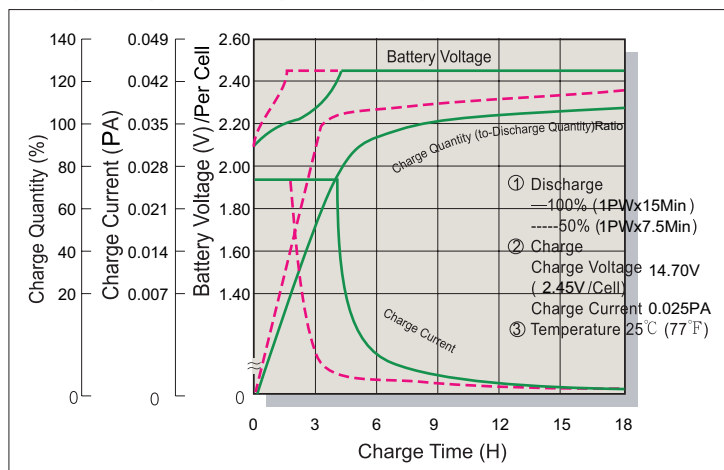

Terminal Voltage (V) and Discharge Time

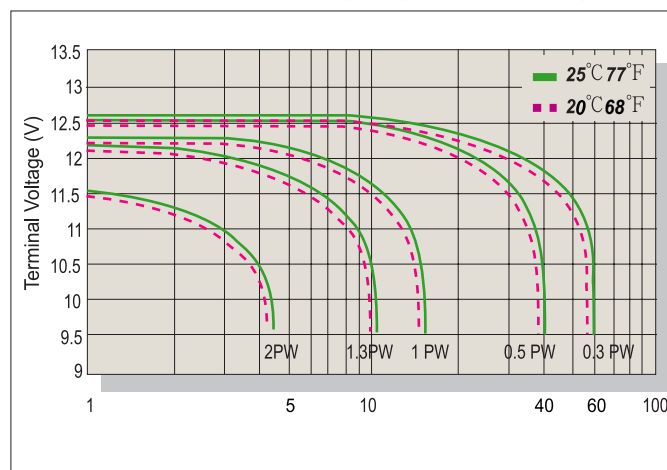

Charging Procedures

Application	Charge Voltage(V/Cell)			Max.Charge Current
	Temperature	Set Point	Allowable Range	
Cycle Use	25°C(77°F)	2.45	2.40~2.50	0.1PA
Standby	25°C(77°F)	2.275	2.25~2.30	

Discharge Current VS. Discharge Voltage

Final Discharge Voltage V/Cell	1.75	1.70	1.60	1.30
Discharge Power(W)	0.1P>(W)	0.1P≤(W)<0.25P	0.25P≤(W)<1.0P	(W)≥1.0P

Sales Office URL: WWW.CSB-BATTERY.COM

CSB BATTERY CO., LTD.
 TAIWAN OFFICE
 Tel: +886-2-2555-5600
 Fax: +886-2-2555-3300
 E-mail: service@csb-battery.com.tw

CSB BATTERY TECHNOLOGIES (BEIJING) CO., LTD.
 BEIJING OFFICE
 Tel: +86-10-59621300/59621301/59621302/59621303
 Fax: +86-10-59621304
 mail: chinasis@csb-battery.com

CSB BATTERY TECHNOLOGIES, INC
 USA OFFICE
 Tel: +1-817-244-7777/1-8003 CSBUSA(272872)
 Fax: +1-817-244-4445
 E-mail: csb@csb-battery.com

CSB BATTERY LOGISTICS (SHANGHAI) CO., LTD.
 SHANGHAI OFFICE
 Tel: +86-21-5046-1622, 5046-0833
 Fax: +86-21-5064-3314
 E-mail: chinasis@csb-battery.com

CSB BATTERY OF NETHERLANDS B.V
 NETHERLANDS OFFICE
 Tel: +31(0) 180 418 140
 Fax: +31(0) 180 418 327
 E-mail: eurosales@csb-battery.com

CSB BATTERY LOGISTIC (SHANGHAI) CO., LTD.
 SHENZHEN OFFICE
 Tel: +86-755-8831-6488/6396/16356
 Fax: +86-755-8831-6548
 mail: she@csb-battery.com.cn